



SICURA, una finestra sul mondo delle persiane



Persiane in alluminio verniciato
Volets batants en aluminium laque
coated aluminium shutters



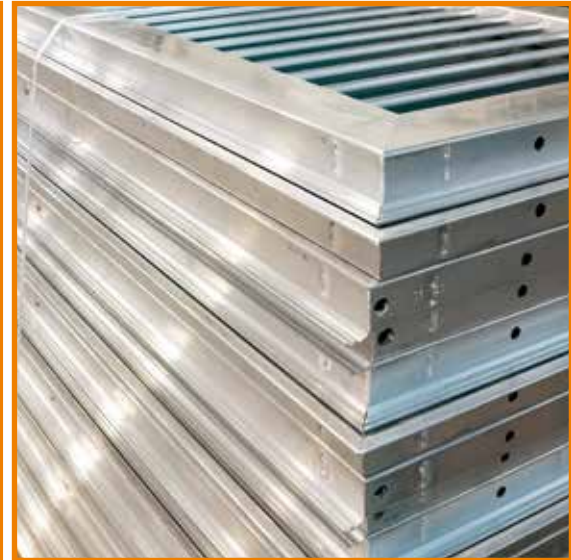

 
Persiane **MADE IN ITALY**



SICURA s.r.l. produce persiane in alluminio dal 1984. Le persiane SICURA sono interamente in alluminio, ciò che ci contraddistingue è la costruzione da materiale grezzo, infatti tutte le nostre persiane, tranne i modelli orientabili e Minipack, vengono verniciate quando sono già assemblate, questo garantisce una maggiore qualità e resistenza agli agenti atmosferici. L'esperienza maturata nel settore ci ha consentito di sviluppare il nostro prodotto in una vasta gamma di modelli, dando sempre la massima importanza alla qualità dei materiali.

SICURA s.r.l. produit des persiennes en aluminium depuis 1984. Les persiennes SICURA sont tout-aluminium, ce qui nous distingue est la fabrication en brut, en effet toutes nos persiennes, exceptées les modèles orientables ou les Minipack, sont laquées après assemblage, ce qui garantit une meilleure qualité et résistance aux agressions atmosphériques. L'expérience acquise dans le secteur nous a permis de développer notre produit dans une gamme étendue de modèles, en donnant toutefois une importance primordiale à la qualité des matériaux employés.

SICURA s.r.l. produces aluminium shutter from 1984. SICURA's shutter are completely in aluminium, our particularity is that we build the shutter from rough aluminium and then the coating is made on already assembled shutter, this system assure a product with long lifetime and easy maintenance. Only adjustable model and Minipack are made from pre-coated aluminium. Our experience in the field has given us the possibility to develop our product in a full range of models, giving always the most importance to the quality of the materials.



Persiana classica a lamelle fisse mm 50x8
Persienné classique à lames arrondies mm 50x8
Classical shutter with fixed slats mm 50x8



Spagnoletta

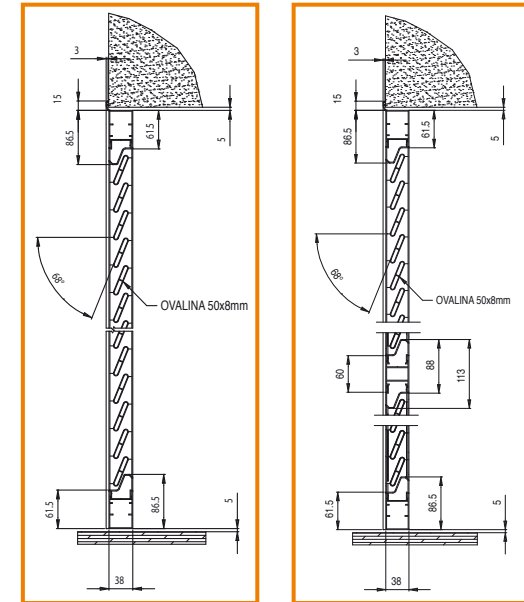

Mod. 2000

Mod. 2001

Mod. 2001

Persiana classica a lamelle fisse mm50x8
 con traverso
 Persienné classique à lames arrondies mm 50x8
 avec traverse
 Classical shutter with fixed slats 50x8
 and cross-member

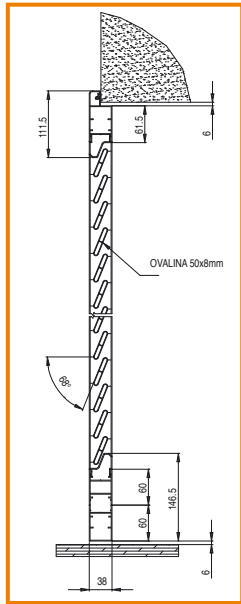

Mod. 2000 PLUS

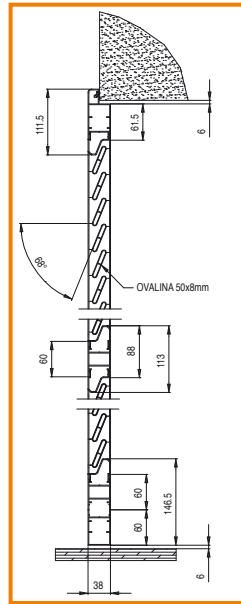

Mod. 2001 PLUS



Cerniera per impacchettamento



Mod. 2000/PLUS
 Persiana classica a lamelle fisse mm 50x8
 Persienné classique à lames arrondies mm 50x8
 Classical shutter with fixed slats mm 50x8

Persiana classica a lamelle fisse 50x8 con traverso
Persienné classique à lames arrondies mm 50x8 avec traverse
Classical shutter with fixed slats 50x8 and cross-member



Persiana a scuretto con doghe da mm 50x10 e traverso

Volte plein lames de mm 50x10 avec traverse

Closed panel shutter with aluminium elements of mm 50x10 and cross-member

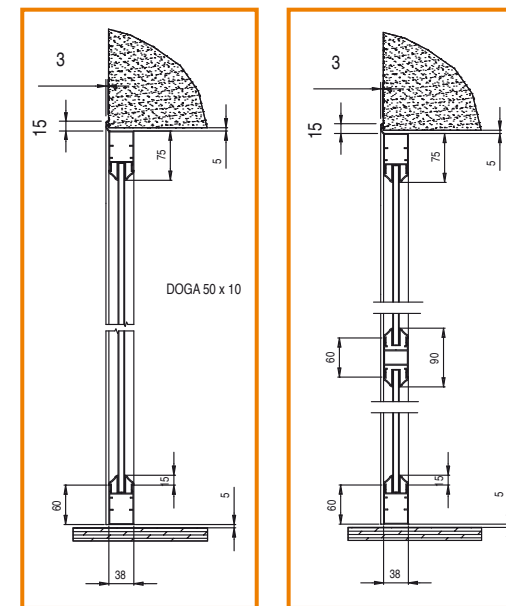

Mod. 2020

Mod. 2021

Mod. 2020

Persiana a scuretto con doghe da mm 50x10

Volet plein lames mm 50x10

Closed panel shutter with aluminium elements of 50x10

Mod. 2022

Persiana mista a lamelle fisse da 50x8 e a scuretto con doghe da 50x10, la parte scuretto può essere a doghe verticali o orizzontali

Mixte persienné arrondies de mm 50x8 et plein lames de 50x10 verticales ou horizontales

Combination with fixed slats 50x8 and closed panel section with aluminium elements 50x10; the closed panel section may have vertical or horizontal aluminium elements

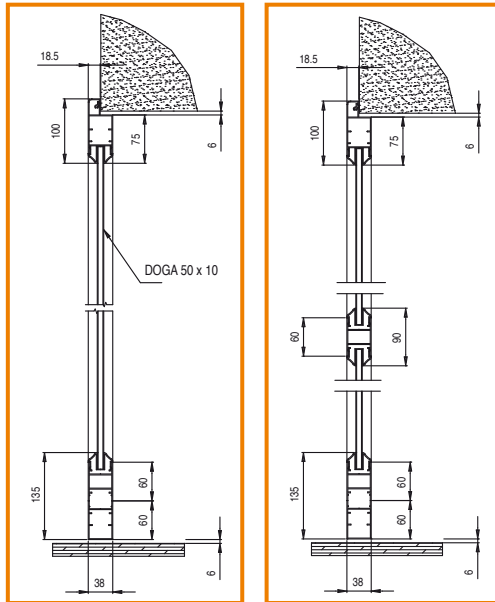

Mod. 2020 PLUS

Mod. 2021 PLUS

Mod. 2020/PLUS

Persiana a scuretto con doghe da 50x10

Volet plein lames mm 50x10

Closed panel shutter with aluminium elements
of 50x10

Mod. 2022/PLUS

Persiana mista a lamelle fisse da mm 50x8 e a

scuretto con doghe da mm 50x10,

la parte scuretto può essere a doghe

verticali o orizzontali

Mixte persienné arrondies de mm 50x8 et plein

lames de mm 50x10 verticales ou horizontales

Combination with fixed slats mm 50x8 and

closed panel section with aluminium elements

mm 50x10; the closed panel section may have

vertical or horizontal aluminium elements



Persiana a scuretto con doghe da 50x10 e traverso

Volet plein lames de mm 50x10 avec traverse

Closed panel shutter with aluminium elements of 50x10 and cross-member



Persiana a scuro con doghe da mm 100x23,5 le doghe possono essere verticali o orizzontali

Volet plein lames de mm 100x23,5 (horizontales ou verticales)

Closed panel shutter with aluminium elements of mm 100x23,5 the aluminium elements may be vertical or horizontal



Cornice



Spagnoletta

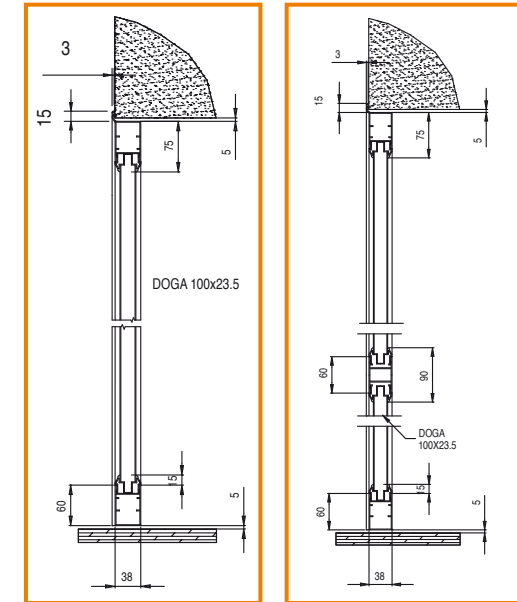

Mod. 2023

Mod. 2025

Mod. 2024

Persiana mista a lamelle fisse da 50x8 e a scuretto con doghe da 100x23,5 la parte scuretto può essere a doghe verticali o orizzontali

Mixte: persienné lames arrondies mm 50x8 et plein lames mm 100x23,5 horizontales ou verticales

Combination with fixed slats 50x8 and closed panel section with aluminium elements 100x23,5; the closed panel section may have vertical or horizontal aluminium elements.

Mod. 2025

Persiana a scuretto con doghe da mm 100x23,5 e traverso

Volet avec plein lames mm 100x23,5 avec traverse

Closed panel shutter with aluminium elements of mm 100x23,5 and cross-member.

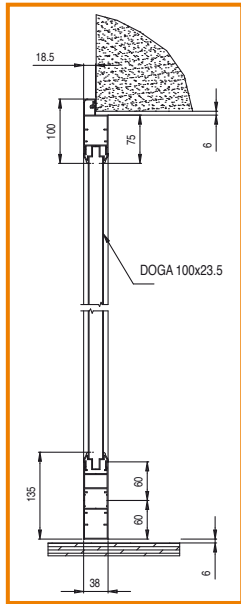

Mod. 2023 PLUS

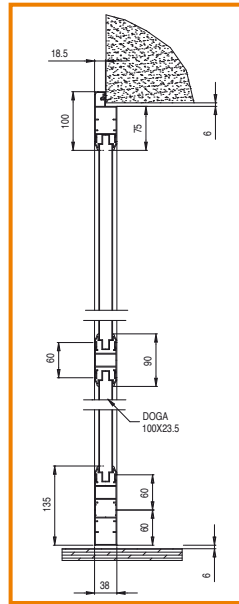

Mod. 2025 PLUS



Doga orizzontale

**Mod. 2024/PLUS**

Persiana mista a lamelle fisse da 50x8 e a scuretto con doghe da 100x23,5 la parte scuretto può essere a doghe verticali o orizzontali

Mixte: persienné lames arrondies mm 50x8 et plein lames mm 100x23,5 horizontales ou verticales

Combination with fixed slats 50x8 and closed panel section with aluminium elements 100x23,5; the closed panel section may have vertical or horizontal aluminium elements.

Mod. 2025/PLUS

Persiana a scuretto con doghe da mm 100x23,5 e traverso

Volet avec plein lames mm 100x23,5 avec traverse

Closed panel shutter with aluminium elements of mm 100x23,5 and cross-member.

Persiana a scuro con doghe da mm 100x23,5 le doghe possono essere verticali o orizzontali

**Volet plein lames de mm 100x23,5 (horizontales ou verticales)
Closed panel shutter with aluminium elements of mm 100x23,5 the aluminium elements may be vertical or horizontal**



Persiana a lamelle romboidali con traverso.
Persienné lames arases avec traverse.
Shutter with rhomb section slats and cross-member.

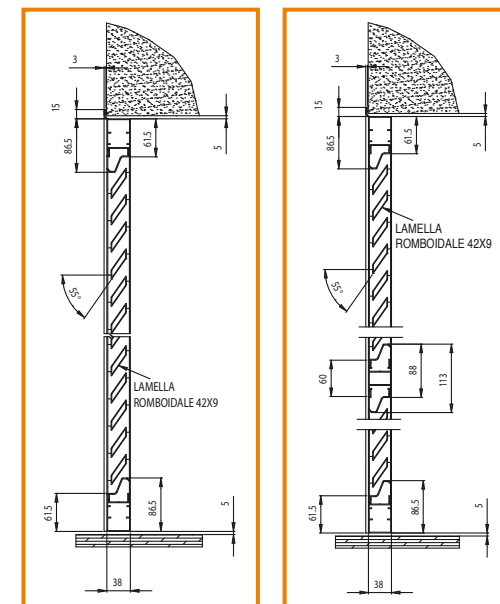

Mod. 2040

Mod. 2041

Mod. 2040

Persiana a lamelle romboidali
 Persienné lames arases à la Française
 Shutter with rhomb section slats

Mod. 2042

Persiana mista a lamelle romboidali e scuretto
 con doghe da mm 50x10
 Mixte persienné lames arases et plein lames
 de mm 50x10
 Combination with rhomb section slats and
 closed panel section with aluminium elements
 of mm 50x10

Mod. 2043

Persiana mista a lamelle romboidali e scuro con
 doghe da mm 100x23,5
 Mixte persienné lames arases et plein lames
 de mm 100x23,5
 Combination with rhomb section slats and
 closed panel section with aluminium elements
 of mm 100x23,5

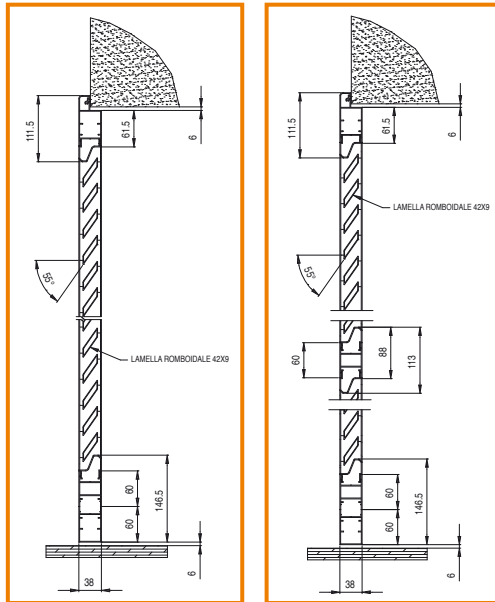

Mod. 2040 PLUS

Mod. 2041 PLUS



Spagnoletta

**Mod. 2040/PLUS**

Persiana a lamelle romboidali.
 Persienné lames arases (à la Française)
 Shutter with rhomb section slats

Mod. 2042/PLUS

Persiana mista a lamelle romboidali e scuretto
 con doghe da mm 50x10
 Mixte persienné lames arases
 et plein lames de mm 50x10
 Combination with rhomb section slats and
 closed panel section with aluminium elements
 of mm 50x10

Mod. 2043/PLUS

Persiana mista a lamelle romboidali e scuro con
 doghe da mm 100x23,5
 Mixte persienné lames arases
 et plein lames de mm 100x23,5
 Combination with rhomb section slats and
 closed panel section with aluminium elements
 of mm 100x23,5



**Persiana a lamelle romboidali con traverso.
 Persienné lames arases avec traverse
 Shutter with rhomb section slats and cross-member**

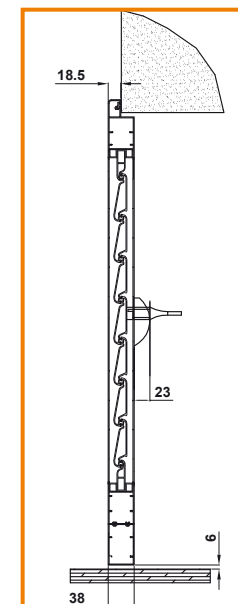

Persiana a lamelle orientabili a goccia da mm 71
Persienné lames orientables de mm 71
Shutter with adjustable slats of mm 71

Mod. 2061/PL

Persiana a lamelle orientabili a goccia da mm 71 e traverso
 Persienné lames orientables de mm 71 et traverse
 Shutter with adjustable slats of mm 71 and cross-member

Mod 2062/PL

Persiana a lamelle orientabili a goccia da mm 71, traverso
 e scuretto orizzontale o verticale con doghe da mm 50x10
 Mixte persienné lames orientables de mm 71, traverse et
 plein lames horizontales ou verticales de mm 50x10
 Combination with adjustable slats, cross member and closed
 panel section with aluminium elements of mm 50x10

Mod 2063/PL

Persiana a lamelle orientabili a goccia da mm 71, traverso
 e scuro orizzontale o verticale con doghe da mm 100x23,5
 Mixte persienné lames orientables de mm 71, traverse et
 plein lames horizontales ou verticales de mm 100x23,5
 Combination with adjustable slats, cross member and closed
 panel section with aluminium elements of mm 100x23,5

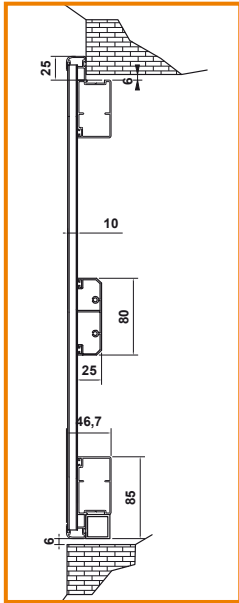

**Persiana a scuro con doghe da mm 80x10 a filo esterno e riquadro interno.
A richiesta realizzabile con doga da mm 50x10.**

**Volet plein à lames de mm 80x10 mm à fil extérieur et cadre intérieur
Variante possible avec des lames de 50x10 mm**

**Closed panel shutter with aluminium elements of 80x10 mm, with frame only in the interior side.
Feasible on request with elements of 50x10 mm**



Persiana a lamelle fisse chiuse a doppia inclinazione.
Volet persienné mais ajouré (lames à double inclinaison)
Shutter with fixed closed slats with the same internal and external inclination.



Dettaglio cerniera telaio

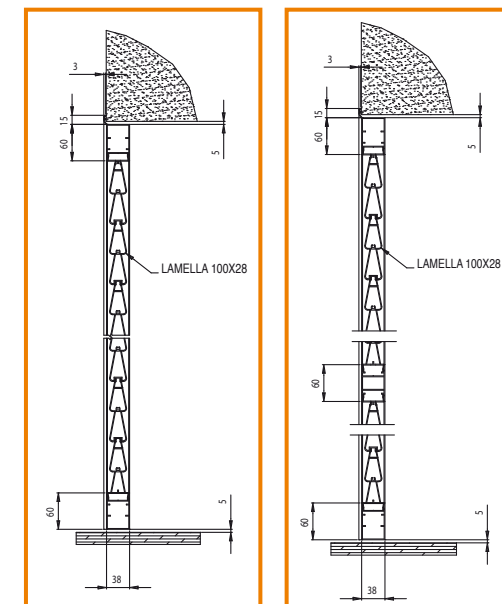

Mod. 2080

Mod. 2081

Mod. 2081

Persiana a lamelle fisse chiuse a doppia inclinazione con traverso.

Volet persienné mais ajouré avec traverse (lames à double inclinaison)

Shutter with fixed closed slats with the same internal and external inclination and cross-member.

Mod. 2082

Persiana mista a lamelle fisse chiuse e scuretto con doghe da mm 50x10

Mixte persienné non ajouré et plein lames de mm 50x10

Combination with fixed closed slats and closed panel section with aluminium elements of mm 50x10

Mod. 2083

Persiana mista a lamelle fisse chiuse e scuretto con doghe da 100x23,5

Mixte persienné non ajouré et plein lames de mm 100x23,5

Combination with fixed closed slats and closed panel section with aluminium elements of 100x23,5

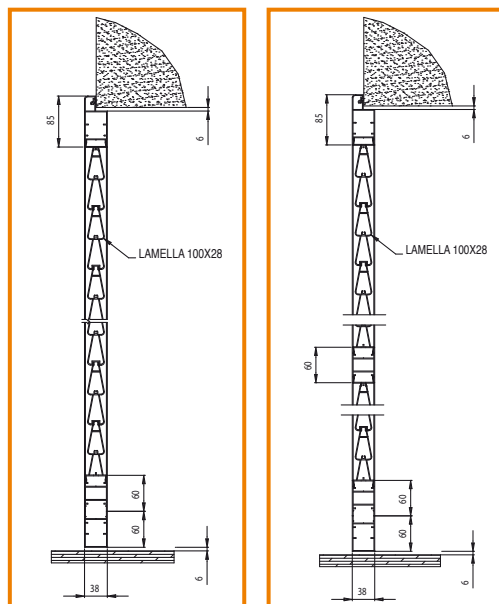

Mod. 2080 PLUS

Mod. 2081 PLUS

**Mod. 2081/PLUS**

Persiana a lamelle fisse chiuse a doppia inclinazione
con traverso

Volet persienné mais ajouré avec traverse (lames à
double inclinaison)

Shutter with fixed closed slats with the same internal
and external inclination and cross-member.

Mod. 2082/PLUS

Persiana mista a lamelle fisse chiuse e scuretto con
doghe da mm 50x10

Mixte persienné non ajouré et plein lames de mm 50x10

Combination with fixed closed slats and closed panel
section with aluminium elements of mm 50x10

Mod. 2083/PLUS

Persiana mista a lamelle fisse chiuse e scuretto con
doghe da 100x23,5

Mixte persienné non ajouré et plein lames
de mm 100x23,5

Combination with fixed closed slats and closed panel
section with aluminium elements of mm 100x23,5

Persiana a lamelle fisse chiuse a doppia inclinazione.

Volet persienné mais ajouré (lames à double inclinaison)

Shutter with fixed closed slats with the same internal and external inclination.



Versione mista



Dettaglio cornice



Cerniera a scomparsa

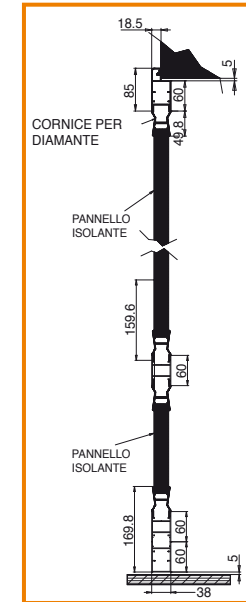

Mod. DIAMANTE PLUS

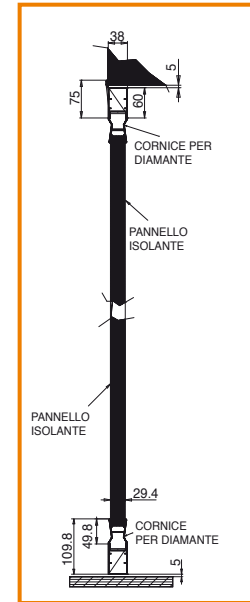

Mod. DIAMANTE 2000

Persiana con specchiatura disegno "Diamante" e pannello isolante interno. Realizzabile nelle soluzioni miste con tutti i tipi di lamella, sia a telaio che a cardini.

Volet type "Pointe de diamant" avec panneau isolant intérieur. Réalisable aussi bien mixte qu'avec tout type de lames, avec ou sans dormant.

Shutter with "Diamond" styling and inside insulating panel. Feasible in combination solutions with all kinds of slats, either on hinges or on 3 or 4 sides frame.

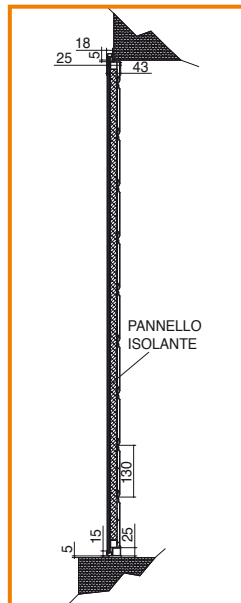

Mod. SCANDOLA



Vista esterna



Doga interna



Doga esterna

**VARIANTI POSSIBILI:**

- doga verticale da mm 80 sia interna che esterna
- doga orizzontale da mm 130 sia interna che esterna

VARIANTES POSSIBLES:

- Lames pleines verticales de 80 mm aussi bien intérieures que extérieures
- Lames pleines horizontales de 130 mm aussi bien intérieures que extérieures.

POSSIBLE COMBINATIONS:

- Vertical aluminium elements of 80 mm both inside and outside
- Horizontal aluminium elements of 130 mm both inside and outside.

Persiana con pannello isolante interno, doghe esterne verticali da mm 80 e doghe interne orizzontali da mm 130. Realizzabile nelle versioni a cardini o a telaio.

Volet avec panneau isolant pris en sandwich par lames pleines verticales extérieures de 80 mm et horizontales intérieures de 130 mm. Réalisable avec ou sans dormant.

Shutter with inside insulating panel, external vertical elements of 80 mm and internal horizontal elements of 130 mm. Assembling on hinges or on 3 or 4 side frame.



Particolare telaio



Cerniera telaio

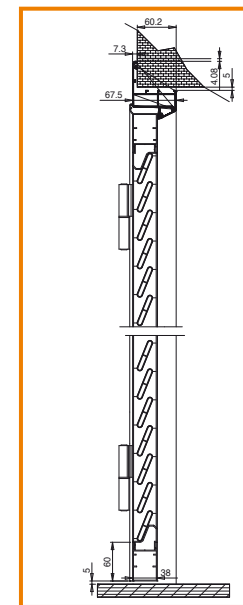

Telaio su 3 lati

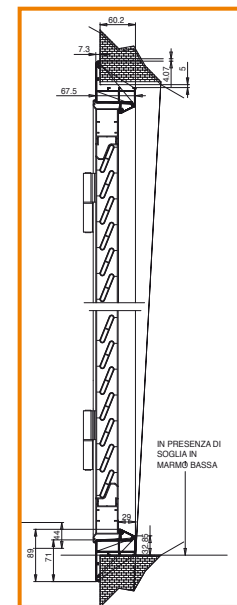

Telaio su 4 lati

**Telaio per serie 2000 realizzabile a 3 o 4 lati,
con canalina per copertura viti di fissaggio.**

**Dormant 3 ou 4 cotes, série 2000,
avec profil capot pour cacher vis de fixation (sauf sur profil cintre).**

**Frame for 2000 models, that can be done on 3 or 4 sides,
with cover for the fastening screws.**

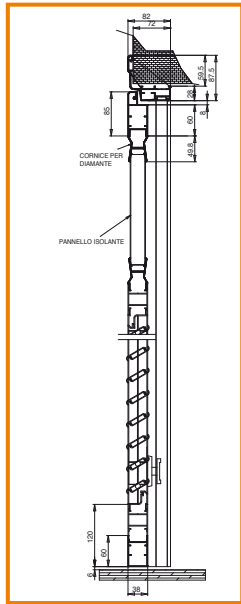

Telaio serie PLUS su 3 lati

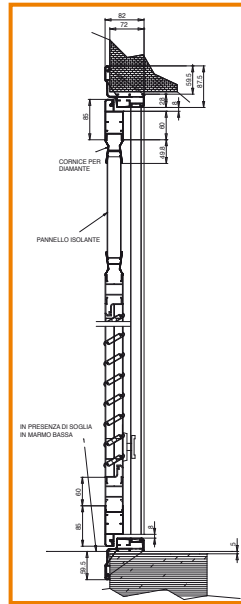

Telaio serie PLUS su 4 lati



Particolare telaio



Particolare cardine a piastra



Telaio per serie PLUS, Diamante e Scandola, realizzabile a 3 o 4 lati, con canalina per copertura viti di fissaggio. Utilizza cardine a piastra applicato sul telaio e cerniere a scomparsa.
Dormant 3 ou 4 cotes pour la série PLUS, "Pointe de Diamant" et Scandola, avec profil capot pour cacher vis de fixation.
Gond sur platine fixe sur dormant et nœud encastré.
Frame for PLUS, Diamante and Scandola models, that can be done on 3 or 4 sides, with cover for the fastening screw. It is used with hinge fixed on the frame and invisible hinge fixed on the panel.

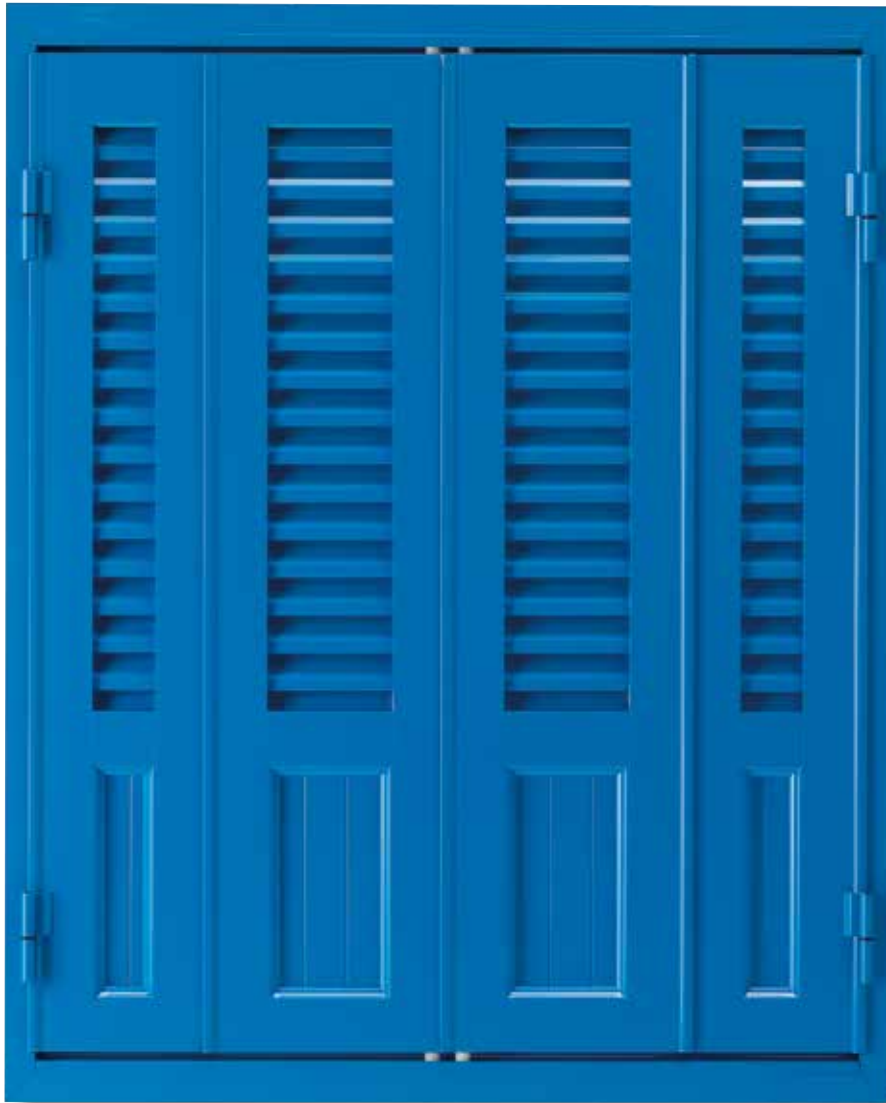

Catenacciolo frontale

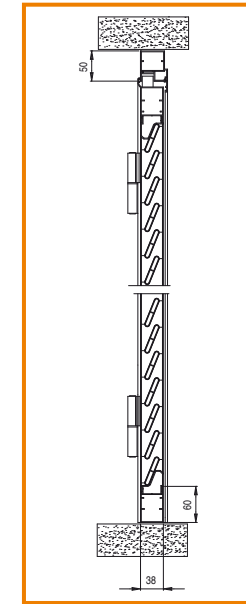
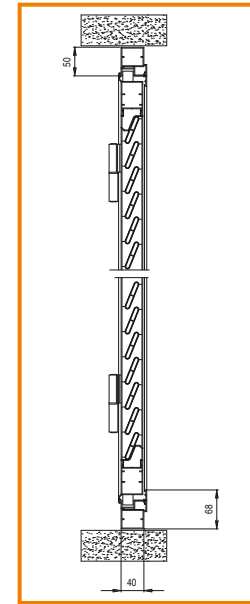
Mod. MONTECARLO
con telaio su 3 latiMod. MONTECARLO
con telaio su 4 lati

Persiana classica ripiegabile con telaio e guida superiore ed inferiore realizzabile in tutti i modelli

Volet persienné repliable avec dormant et rail supérieur et inférieur, réalisable dans tous les modèles

Classical folding shutter with frame and upper and lower runner, available on all models

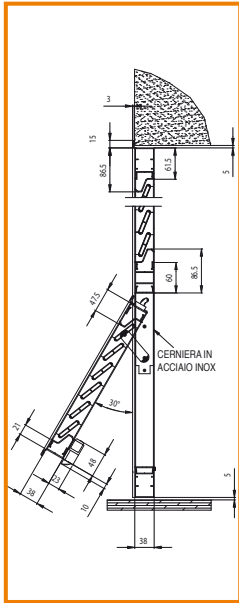

Mod. .../G



Persiane con sportellino alla "Genovese";
realizzabile in tutti i modelli della serie 2000 e Plus

Persienné avec battant (portissol);
réalisable in tous le modèle des séries 2000 et Plus

Shutter with projecting flap;
possible on all models of the 2000 and Plus series genovese



Maniglia "vaschetta"

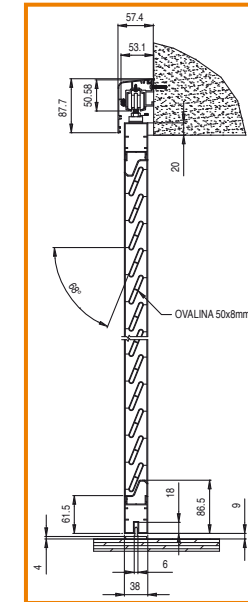

Mod. Scorrevole



Tipo scorrevole per serie 2000 montaggio esterno muro
 Montage Coulissante sur rail supérieur
 Sliding system on top guide

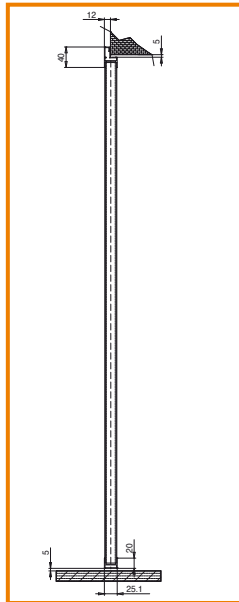

Mod. 2090 PLUS

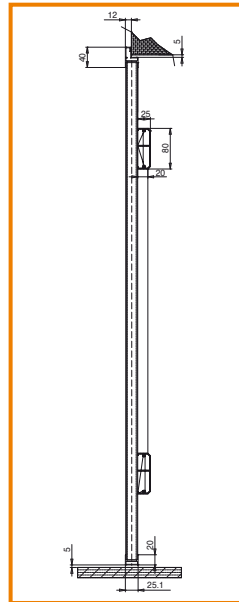

Mod. 2090/Z PLUS

**Mod. 2090 PLUS**

Antone classico con doghe da 100x23,5

Volet plein lames de mm 100x23,5

Classical panel shutter with aluminium elements
of mm 100x23,5

Mod. 2090/Z PLUS

Antone classico con doghe da 100x23,5 e
rinforzo a Z.

Volet plein lames de mm 100x23,5 à barres et
ècharpes

Classical panel shutter with aluminium elements
of 100x23,5 and Z reinforcement

**Profilo anta di contorno da mm 20x25 con o senza battuta
da mm 20. Antone classico con doghe da mm 100x23,5**

**Profil cadre de mm 20x25 avec ou sans battue de mm 20
Volet plein lames de mm 100x23,5**

**Outline profile of mm 20x25 with or without central closure of mm 20
Classical panel shutter with aluminium elements of mm 100x23,5**



Fermapersiana



Tinta noce



Tinta pino

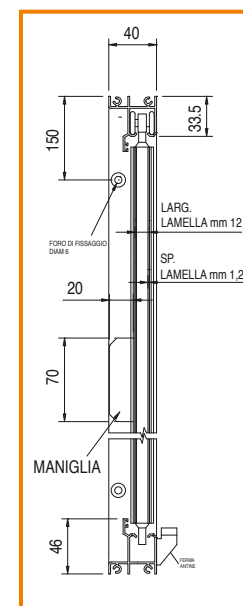

Mod. MINIPACK finestra

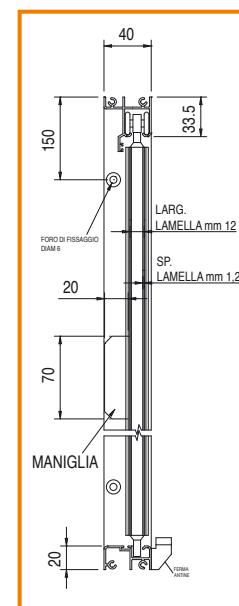

Mod. MINIPACK portafinestra

Composta da pannelli monoblocco articolati che si ripiegano sui fianchi, presentando un ingombro ridottissimo di soli 27 mm per coppia. Ha telaio a 4 lati con guida superiore ed inferiore, sospensione a scorrimento con carrelli autolubrificanti e bussole in poliammide. Accessori e viteria inossidabili.

Cette persienné est constituée par des panneaux monoblocs articulés, les panneaux se replient sur les cotés de telle sorte qu'ils n'occupent qu'un espace extrêmement réduit de 27 mm par paire. Bâti à quatre cotés avec guide supérieur et inférieur, suspension à coulisse avec chariots autolubrifiants et douilles en polyamide. Accessoires et visserie inoxydable.

It consist of one-piece panels with articulated joints that fold at the sides to give an extremely compact size of just 27 mm per pair.

It has four side frame with upper and lower runner, sliding suspension with self-lubricating carriages and polyamide bushes. Stainless accessories



Maniglia in alluminio



Catenacciolo incassato



Catenacciolo frontale



Variante Minipack 3

Chiusura a superficie ondulata
Surface ondulée en position fermée
Closure with undulated surface

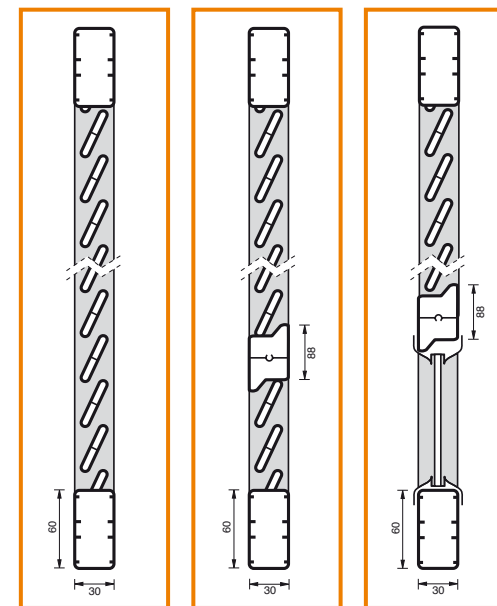

Mod. 30

Mod. 31

Mod. 33

Mod. 30

Persiana classica con lamelle fisse aperte da mm 50x8

Persienné classique avec lames de mm 50x8

Classical shutter with fixed slats of 50x8 mm

Mod. 31

Persiana classica con lamelle fisse aperte da mm 50x8 e traverso

Persienné classique avec lames de mm 50x8 et traverse

Classical shutter with fixed slats of 50x8 mm and cross-member

Mod. 33

Persiana mista a lamelle fisse da 50x8 e scuretto con doghe da mm 50x10.

Mixte persienné arrondies de mm 50x8 et plein lames de mm 50x10

Combination with fixed slats of 50x8 and closed panel shutter with elements of 50x10 mm.

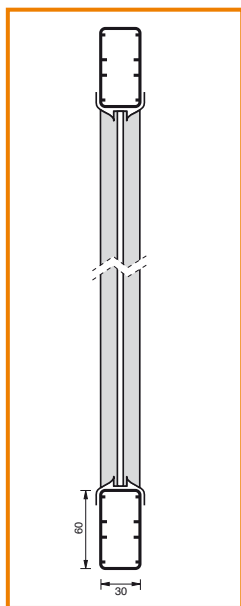

Mod. 32

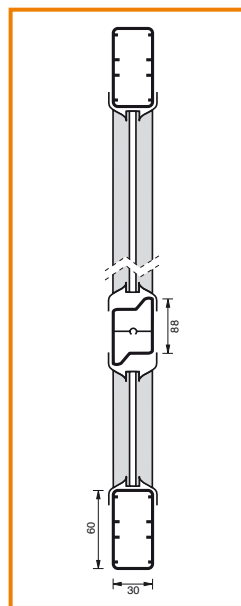

Mod. 32/1

**Mod. 32**

Persiana a scuretto con doghe da mm 50x10
 Volet avec plein lames de mm 50x10
 Closed panel shutter with elements of
 50x10 mm

Mod. 32/1

Persiana a scuretto con doghe da mm 50x10 e
 traverso.
 Volet avec plein lames de mm 50x10 et traverse
 Closed
 panel shutter with elements of 50x10 mm and
 cross-member.

**Mod. .../C**

Persiane con lato superiore curvo a raggio di centinatura variabile; realizzabili in tutti i modelli

Persienné à rayon de cintrage variable;
réalisable avec tous modèle

Shutter with variable sweep; possible in every
model



Persiana di sicurezza modello ECO "Certificata Classe 3 UNI-ENV 1627. Realizzata con profili in acciaio zincato altoresistenziale, finitura con verniciatura a polveri poliestere

Volet de sécurité modèle ECO "certifiée classe 3 uni-env 1627". Fabriqué avec des profilés en acier zingué à haute résistance, laquage poudre polyester.

Security shutter ECO model, Certified 3rd Class UNI-ENV 1627. Made in high strength galvanized steel, Surface finish with polyester powder coating.



Cerniera tripla



Pioli antistrappo



Persiana a lamelle rinforzate con piatto in acciaio inserito all'interno delle lamelle e del montante, realizzabile nei modelli 2000 e 2040 della serie 2000, per una maggiore sicurezza consigliamo il montaggio con telaio, cerniere triple, pioli antistrappo e serratura

Persienné avec renfort en acier inséré dans les lames, réalisable dans les modèle 2000 et 2040 de la série 2000, pour une plus grand sécurité nous conseillons le montage sur dormant, triple charnière, et serrure

Shutter with internal steel reinforcement, possible in 2000 and 2040 model series 2000, for higher level of security it is advisable to assembly with frame, triple hinges and lock

Persiana a lamelle rinforzate
Persienné avec renfort
Shutter with internal steel reinforcement

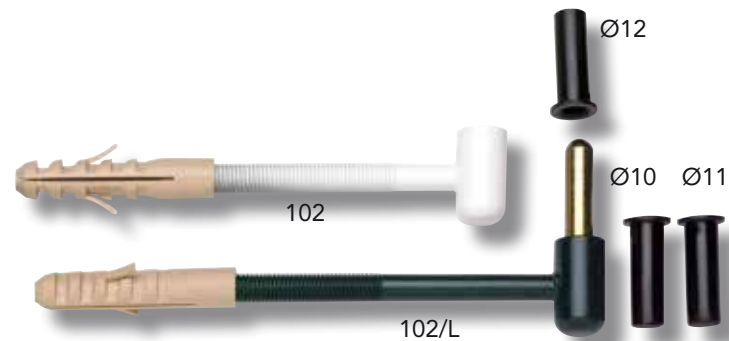
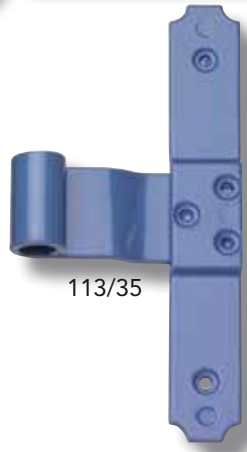
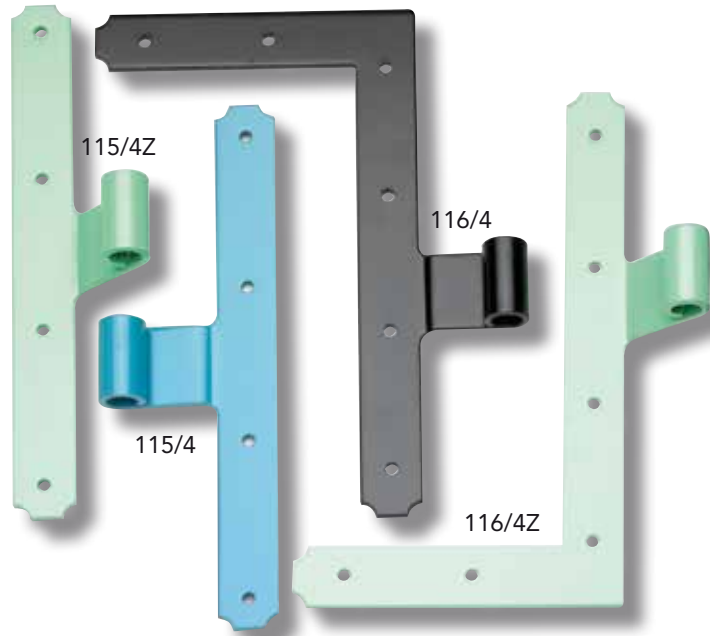



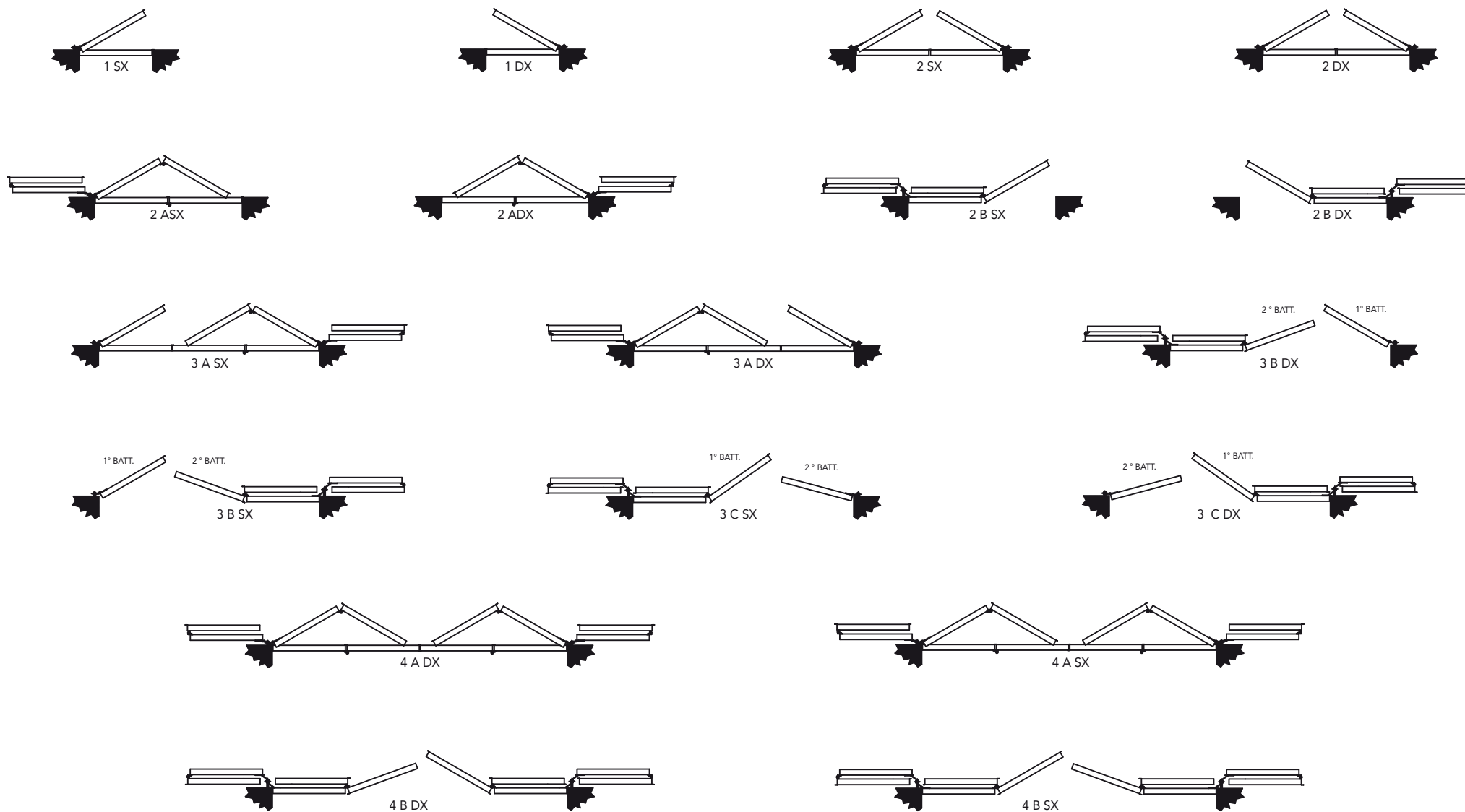

Tutti i sistemi di apertura "BDX e BSX" "CDX e CSX" non sono realizzabili con il telaio

Tous les systemes d'ouverture "BDX et BSX" "CDX et CSX" ne sont pas realisable avec le dormant

The opening systems "BDX and BSX" "CDX and CSX" cannot be done whit the frame



Tipo C : Montaggio con cardini
Type C: Montage sur gonds
Type C : Assembly on hinges



Tipo T/3: Montaggio con telaio su 3/4 lati
Type T/3: Montage sur dormant 3/4 cotes
Type T/3: Assembly with frame on 3/4 sides



Tipo S: Montaggio scorrevole
Type S: Montage coulissant sur rail supérieur
Type S: Sliding assembly



Cooperativa USFA

Via Ai Cioss c.p. 155
6593 CADENAZZO
T. +41 91 858 00 69
F. +41 91 858 00 70

OFFERTA

ORDINE

DEL/...../.....

CLIENTE :

Indirizzo :

Tel./Fax :

P.Iva :

VS. RIF. :

Prodotto certificato CE

PERSIANE IN ALLUMINIO COLORE : Misure : CONSEGNA PREVISTA

POS. N°	N° Finestre	Largezza in cm	Altezza in cm	Tipo	Modello	Pannelli finestra	Altezza traverso	Altezza maniglia	Sistema apertura	(1)Tipo maniglia	Note e accessori speciali	Prezzo unitario €	Numero N°	Prezzo totale €
1														
2														
3														
4														
5														
6														
7														
8														
9														
10														

TOT. m²

VALIDITA' DELL'OFFERTA: 60 GG

- (1) Maniglia cremonese = C
 Maniglia spagnoletta = S
 Vaschetta x scorrevole = V
 Serratura a 2 mandate = M2
 Serratura su 3 punti = M3

**TIPO"
C"**

- Cerniere a T regol. Cerniere a T montate
 Cerniere a T fisse Cerniere a T smontate
 Cardini da murare
 Cardini a vite

Pagamento:	Acconto:	Saldo:
------------	----------	--------

FIRMA DEL CLIENTE

.....

TOTALE
Sconto
Trasporto
Imponibile
I.V.A.
TOTALE €
s.e. & o.

Banca d'appoggio:

ABI: CAB:

